

MINIMA[®]

FORMES JUNIOR

JUNIOR SHAPES
FORMAS JUNIOR
FORMEN FÜR KINDERBRILLEN
FORMAS JUNIOR

M-Junior-22
M-Junior-22G

M-Junior

Pont traditionnel Junior
Junior traditional bridge

M-Junior-22
M-Junior-22G

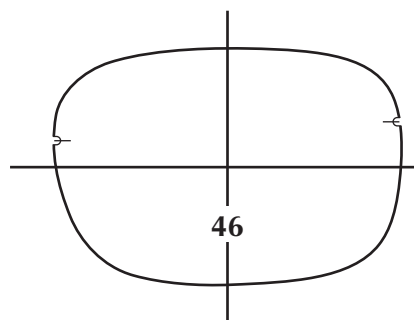
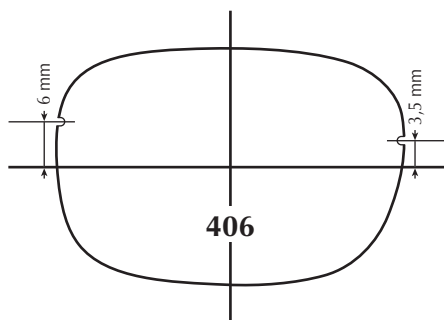
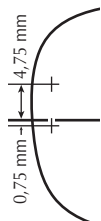
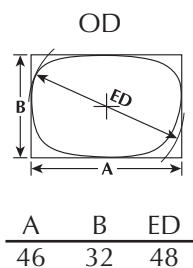
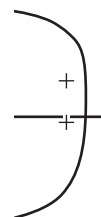
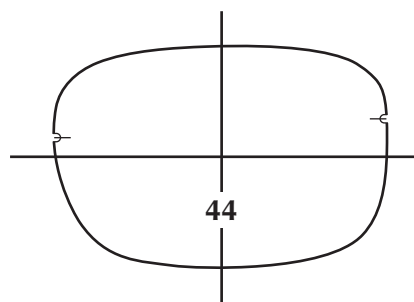
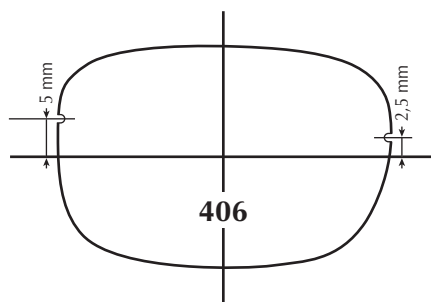
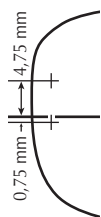
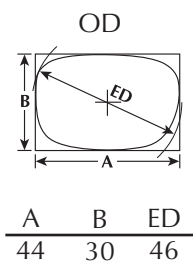
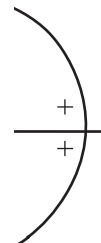
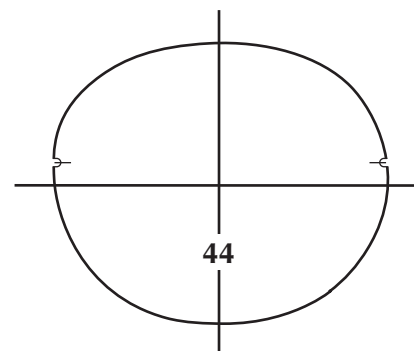
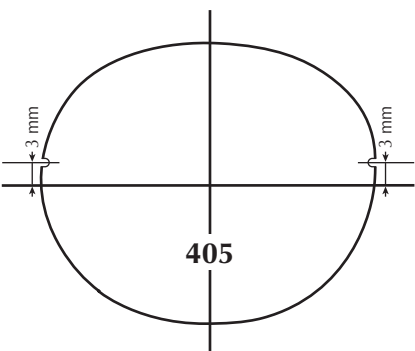
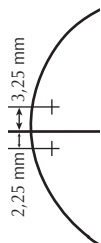
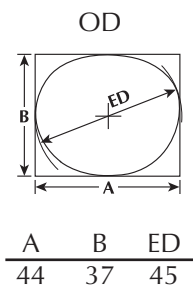
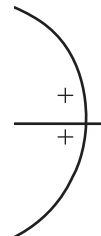
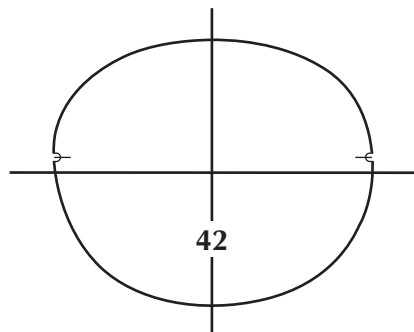
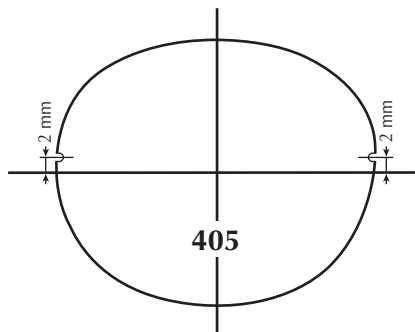
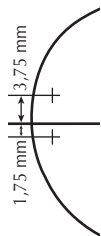
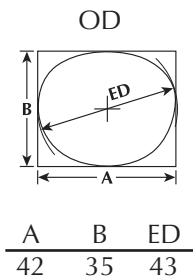

Toutes ces informations sont communiquées à titre indicatif et doivent être adaptées à la forme du nez du porteur.
All infos provided must be adapted to shape and size of the patient's nose.

⚠ Attention : certaines imprimantes peuvent ne pas reproduire ce document à l'échelle exacte.
Note: some printers may not duplicate this document at the correct scale.



M-Junior-22
M-Junior-22G

M-Junior

Pont traditionnel Junior
Junior traditional bridge

M-Junior-22
M-Junior-22G

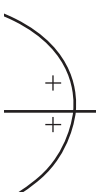
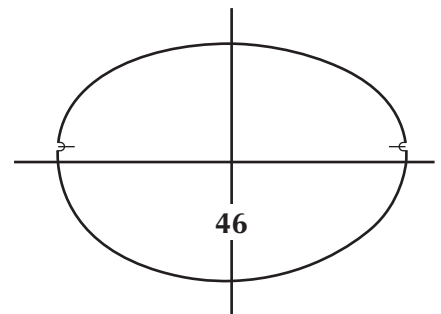
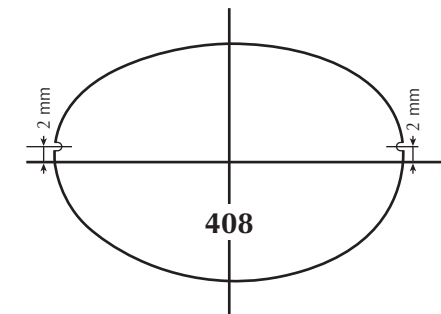
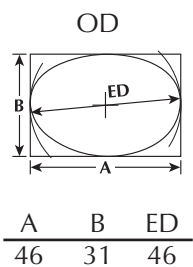
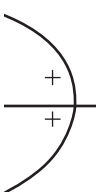
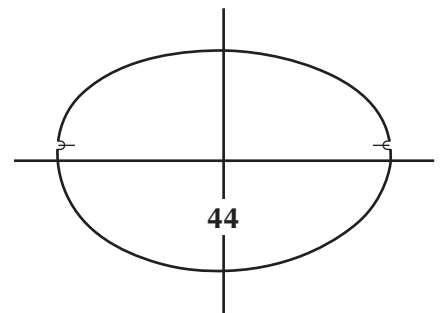
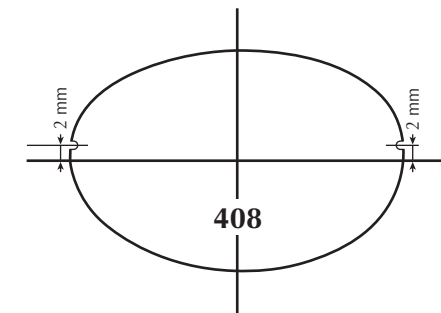
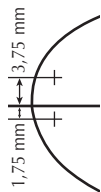
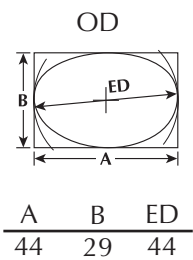
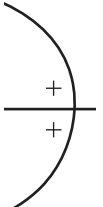
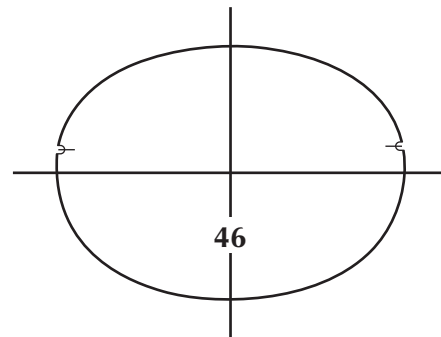
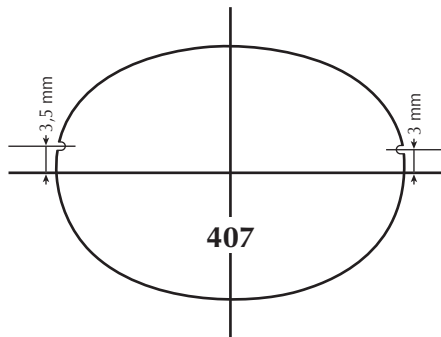
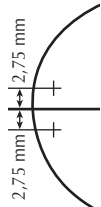
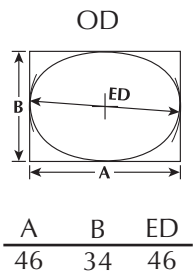
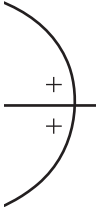
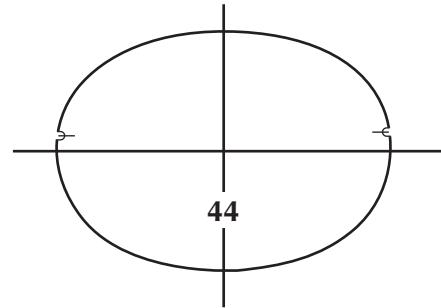
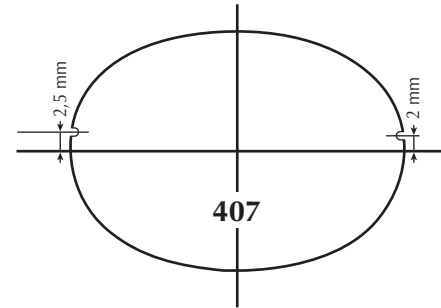
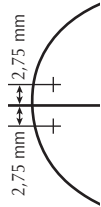
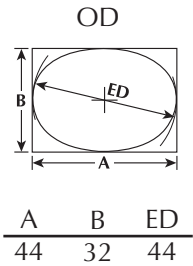

Toutes ces informations sont communiquées à titre indicatif et doivent être adaptées à la forme du nez du porteur.
All infos provided must be adapted to shape and size of the patient's nose.

⚠ Attention : certaines imprimantes peuvent ne pas reproduire ce document à l'échelle exacte.
Note: some printers may not duplicate this document at the correct scale.



M-Junior-22
M-Junior-22G

M-Junior

Pont traditionnel Junior
Junior traditional bridge

M-Junior-22
M-Junior-22G

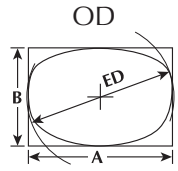

A	B	ED
44	30	45

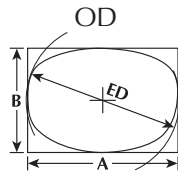
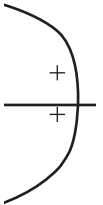
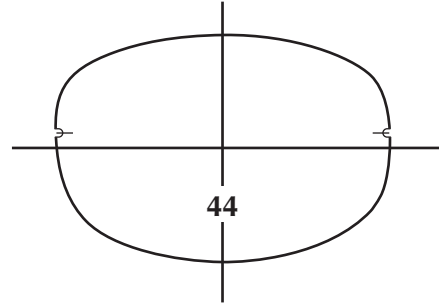
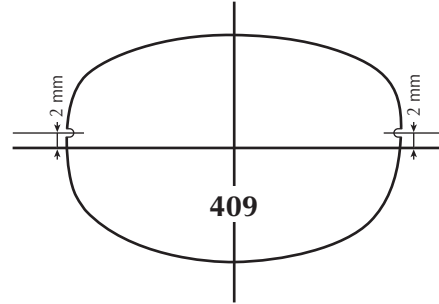
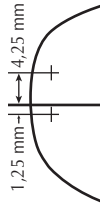

A	B	ED
46	32	47

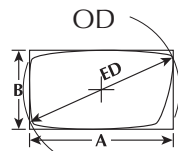
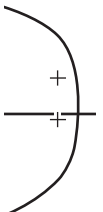
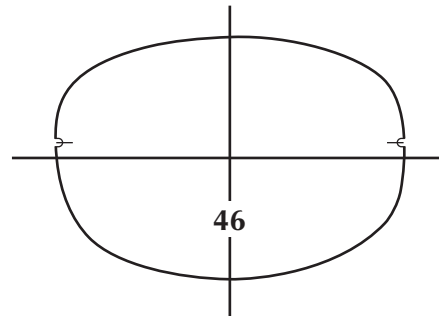
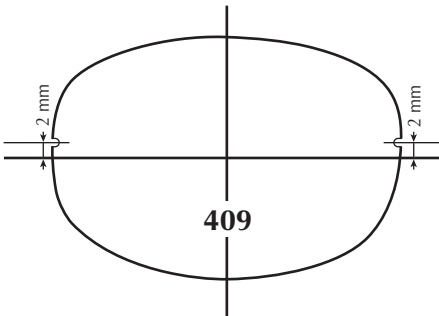
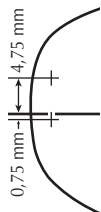

A	B	ED
44	24	48

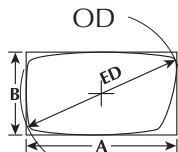
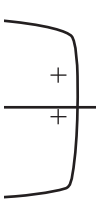
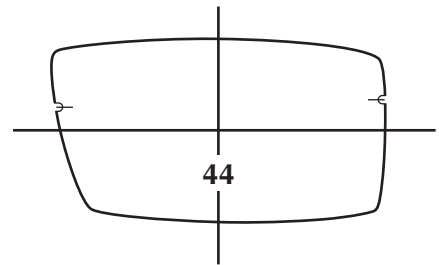
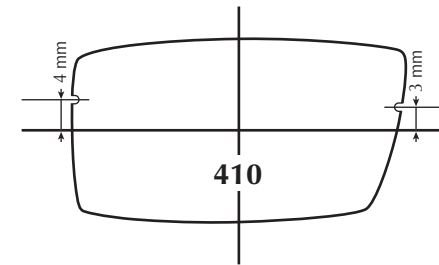
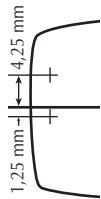

A	B	ED
46	26	50

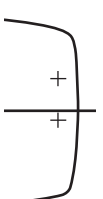
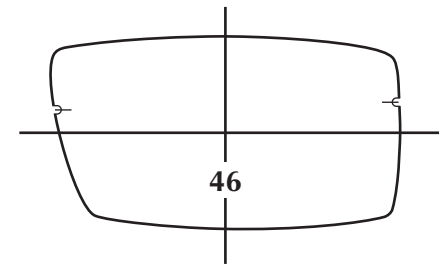
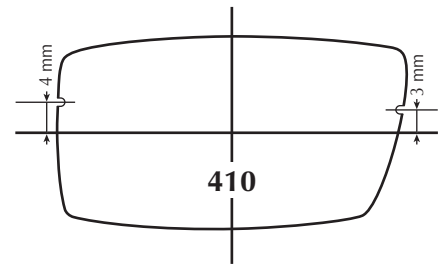
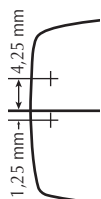

Toutes ces informations sont communiquées à titre indicatif et doivent être adaptées à la forme du nez du porteur.
All infos provided must be adapted to shape and size of the patient's nose.

⚠ Attention : certaines imprimantes peuvent ne pas reproduire ce document à l'échelle exacte.
Note: some printers may not duplicate this document at the correct scale.



M-Junior-22
M-Junior-22G

M-Junior

Pont traditionnel Junior
Junior traditional bridge

M-Junior-22
M-Junior-22G

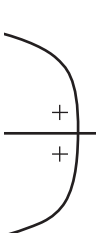
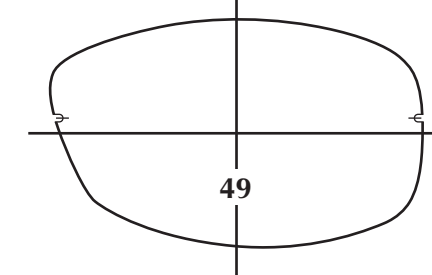
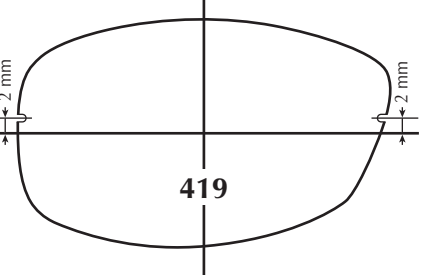
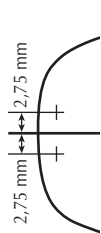
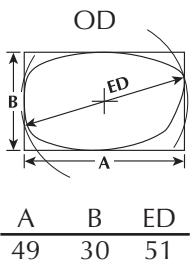
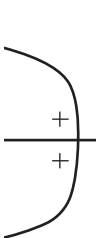
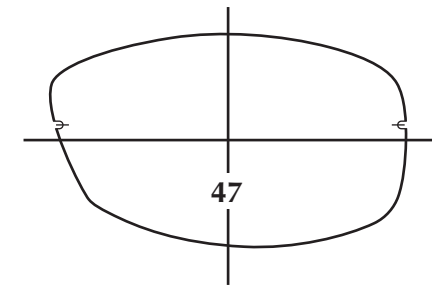
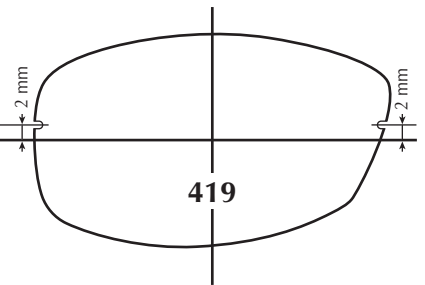
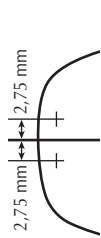
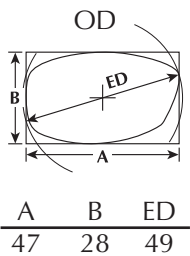
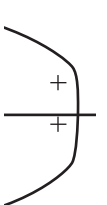
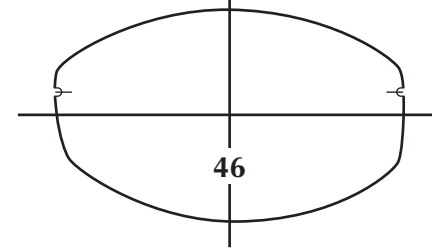
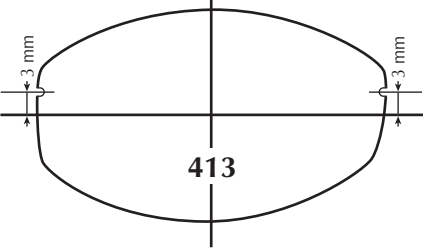
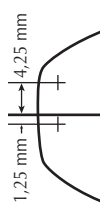
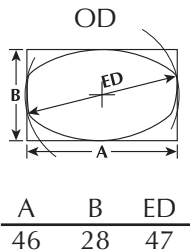
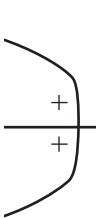
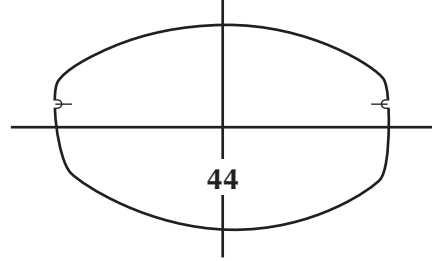
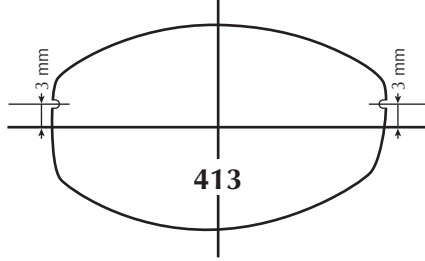
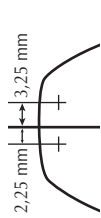
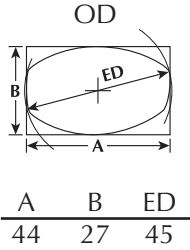

Toutes ces informations sont communiquées à titre indicatif et doivent être adaptées à la forme du nez du porteur.
All infos provided must be adapted to shape and size of the patient's nose.

⚠ Attention : certaines imprimantes peuvent ne pas reproduire ce document à l'échelle exacte.
Note: some printers may not duplicate this document at the correct scale.



M-Junior-22
M-Junior-22G

M-Junior

Pont traditionnel Junior
Junior traditional bridge

M-Junior-22
M-Junior-22G

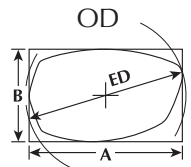

A	B	ED
47	29	49

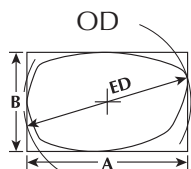
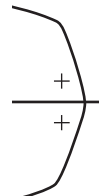
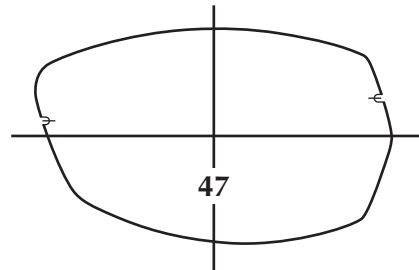
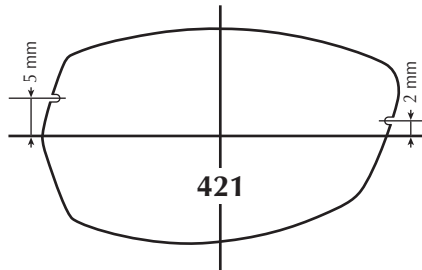
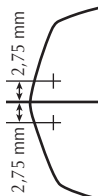

A	B	ED
49	30	51

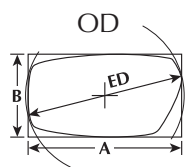
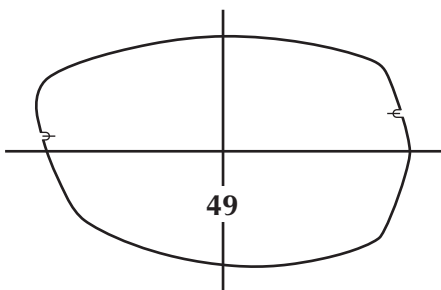
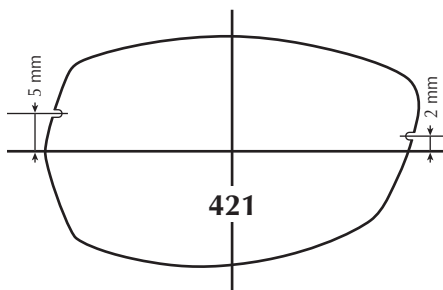

A	B	ED
47	25	49

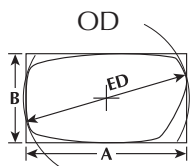
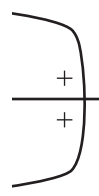
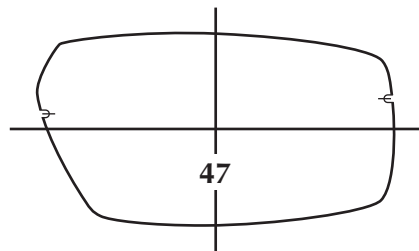
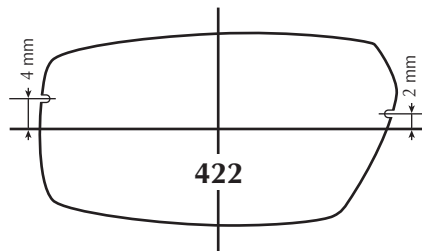
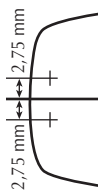

A	B	ED
49	27	51

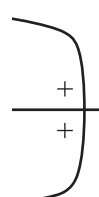
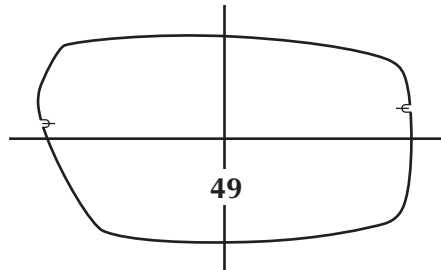
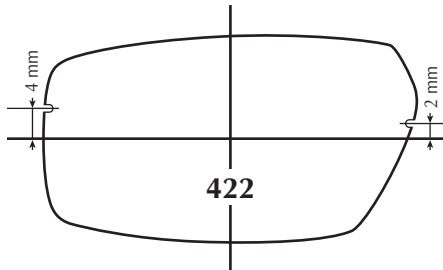

Toutes ces informations sont communiquées à titre indicatif et doivent être adaptées à la forme du nez du porteur.
All infos provided must be adapted to shape and size of the patient's nose.

⚠ Attention : certaines imprimantes peuvent ne pas reproduire ce document à l'échelle exacte.
Note: some printers may not duplicate this document at the correct scale.



M-Junior-22
M-Junior-22G

M-Junior

Pont traditionnel Junior
Junior traditional bridge

M-Junior-22
M-Junior-22G

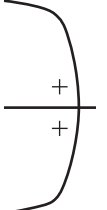
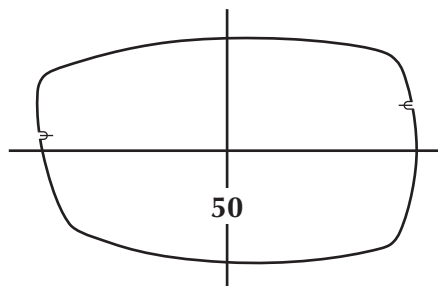
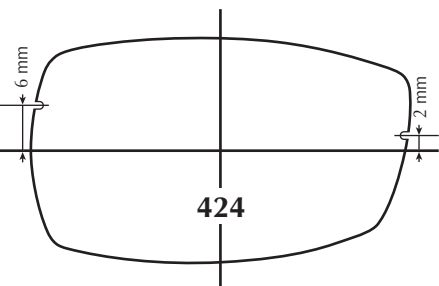
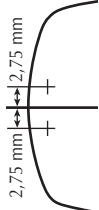
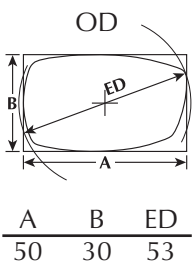
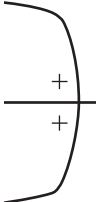
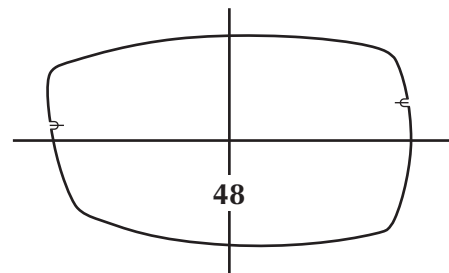
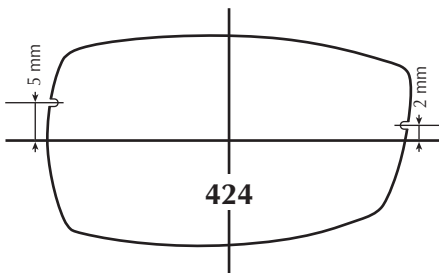
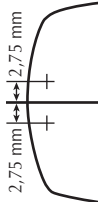
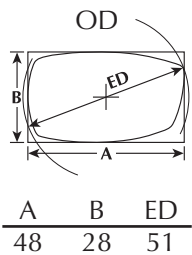
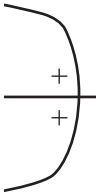
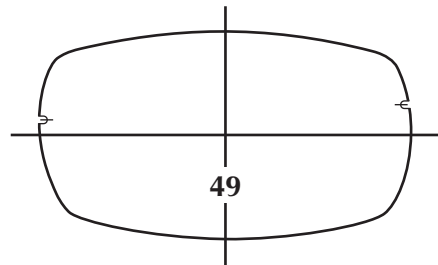
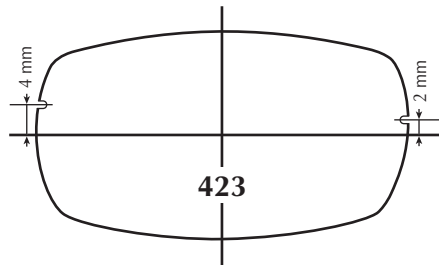
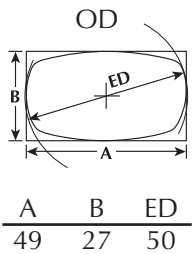
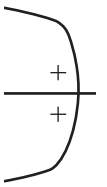
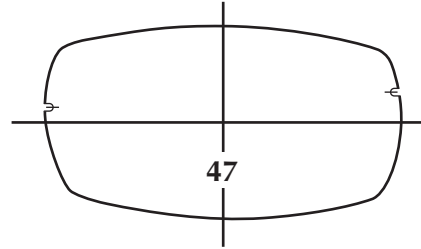
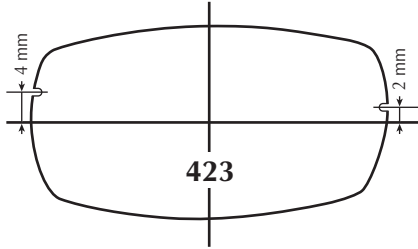
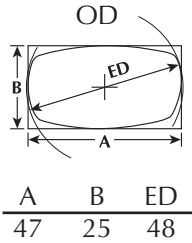

Toutes ces informations sont communiquées à titre indicatif et doivent être adaptées à la forme du nez du porteur.
All infos provided must be adapted to shape and size of the patient's nose.

⚠ Attention : certaines imprimantes peuvent ne pas reproduire ce document à l'échelle exacte.
Note: some printers may not duplicate this document at the correct scale.



M-Junior-22
M-Junior-22G

M-Junior

Pont traditionnel Junior
Junior traditional bridge

M-Junior-22
M-Junior-22G

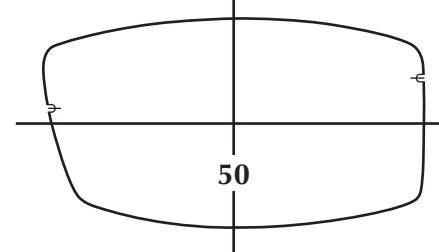
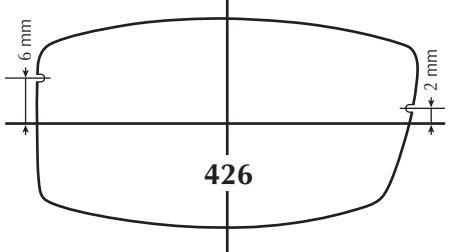
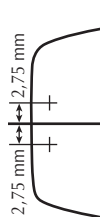
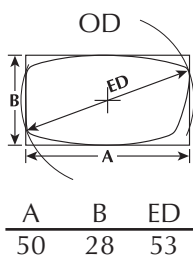
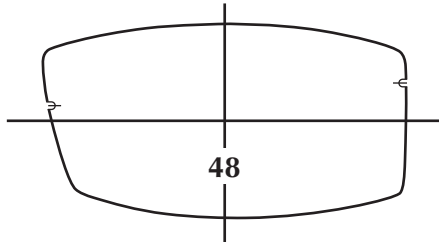
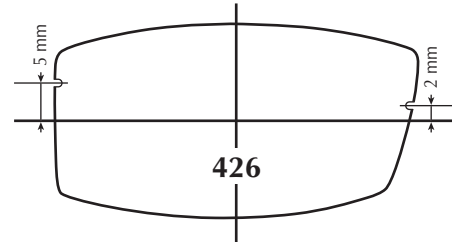
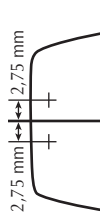
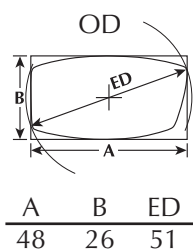
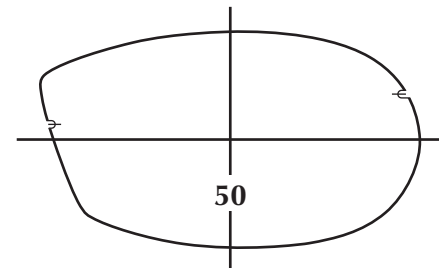
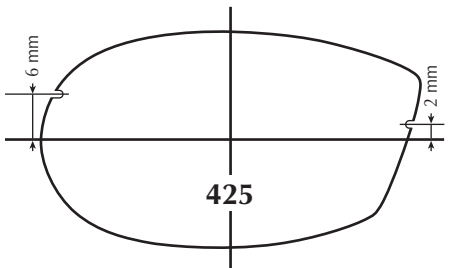
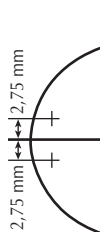
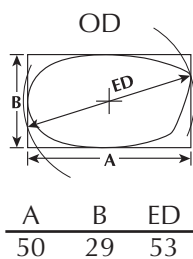
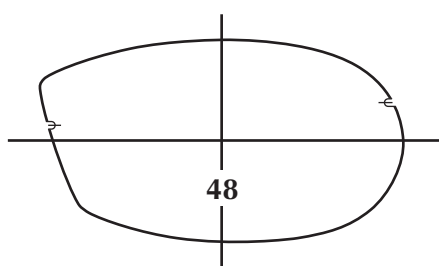
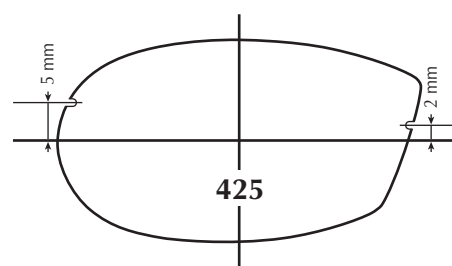
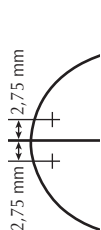
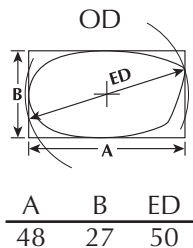

Toutes ces informations sont communiquées à titre indicatif et doivent être adaptées à la forme du nez du porteur.
All infos provided must be adapted to shape and size of the patient's nose.

⚠ Attention : certaines imprimantes peuvent ne pas reproduire ce document à l'échelle exacte.
Note: some printers may not duplicate this document at the correct scale.



M-Junior-22
M-Junior-22G

M-Junior

Pont traditionnel Junior
Junior traditional bridge

M-Junior-22
M-Junior-22G

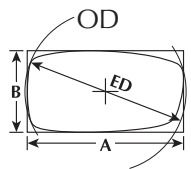

A	B	ED
48	25	49

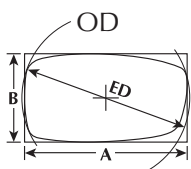
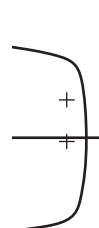
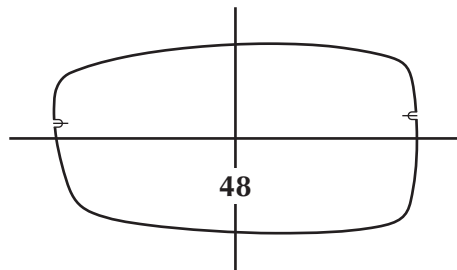
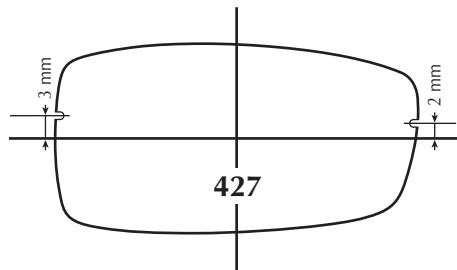
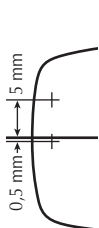

A	B	ED
50	27	51

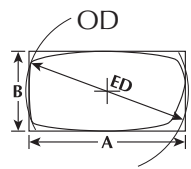
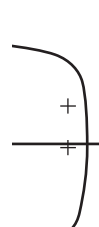
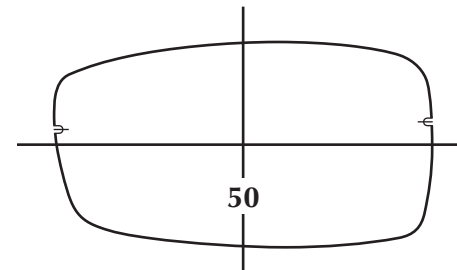
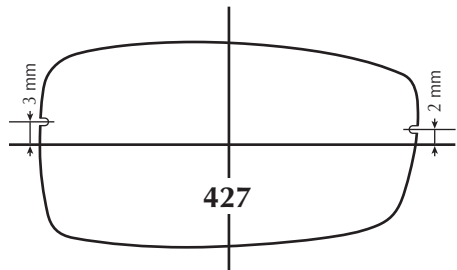
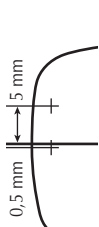

A	B	ED
48	24	50

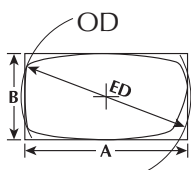
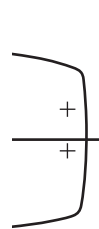
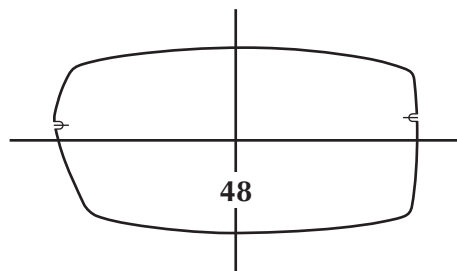
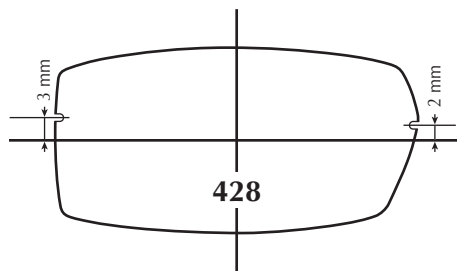
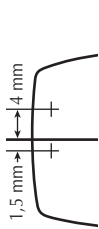

A	B	ED
50	26	52

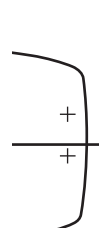
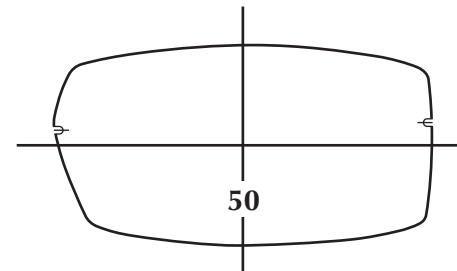
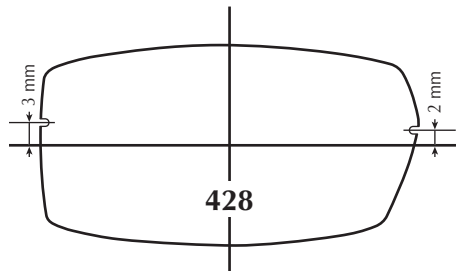
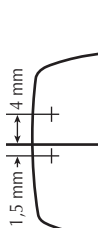

Toutes ces informations sont communiquées à titre indicatif et doivent être adaptées à la forme du nez du porteur.
All infos provided must be adapted to shape and size of the patient's nose.

⚠ Attention : certaines imprimantes peuvent ne pas reproduire ce document à l'échelle exacte.
Note: some printers may not duplicate this document at the correct scale.



M-Junior-22
M-Junior-22G

M-Junior

Pont traditionnel Junior
Junior traditional bridge

M-Junior-22
M-Junior-22G

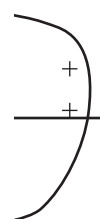
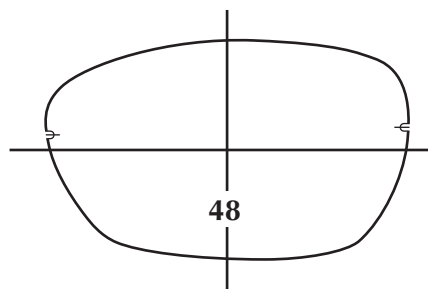
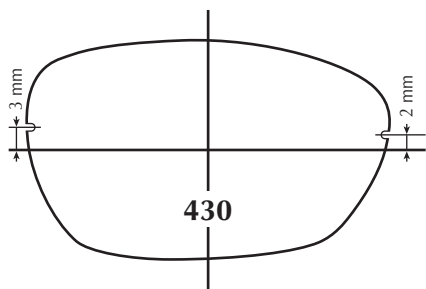
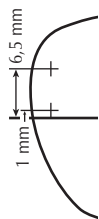
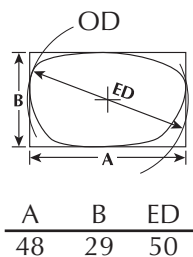
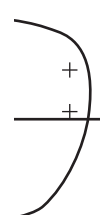
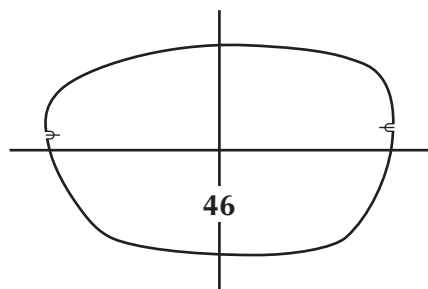
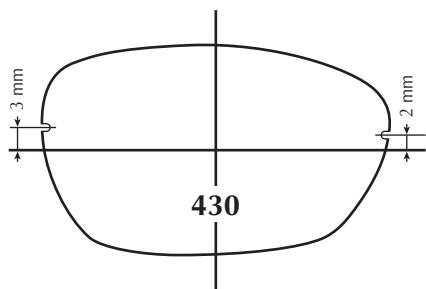
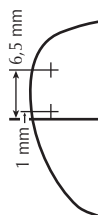
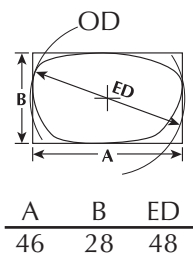
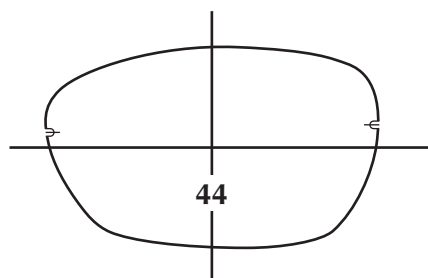
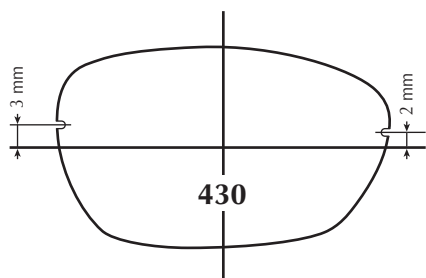
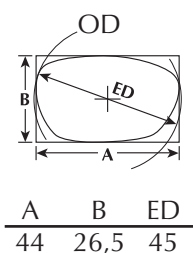
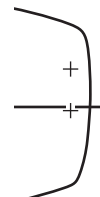
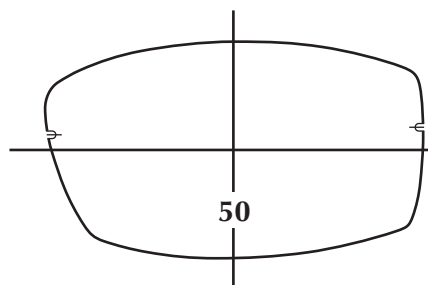
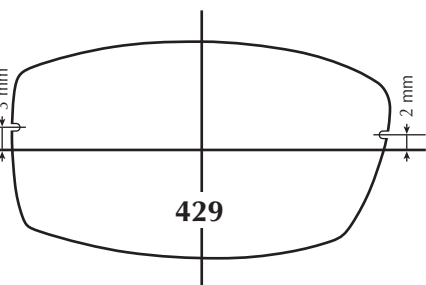
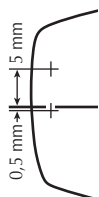
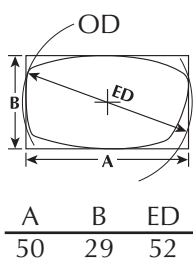
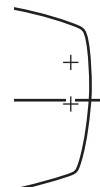
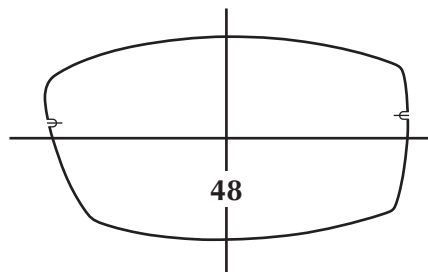
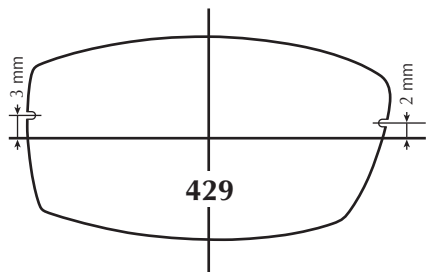
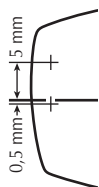
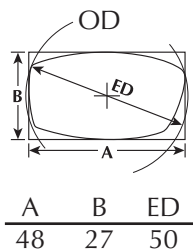

Toutes ces informations sont communiquées à titre indicatif et doivent être adaptées à la forme du nez du porteur.
All infos provided must be adapted to shape and size of the patient's nose.

⚠ Attention : certaines imprimantes peuvent ne pas reproduire ce document à l'échelle exacte.
Note: some printers may not duplicate this document at the correct scale.



M-Junior-22
M-Junior-22G

M-Junior

Pont traditionnel Junior
Junior traditional bridge

M-Junior-22
M-Junior-22G

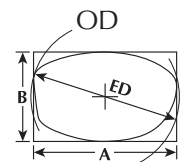

A	B	ED
44	27,5	46

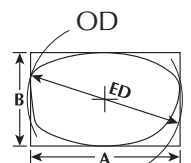

A	B	ED
46	29	48

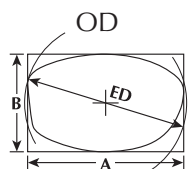

A	B	ED
48	30	50

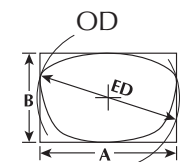

A	B	ED
42	27,5	44

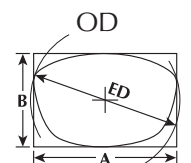

A	B	ED
44	29	46

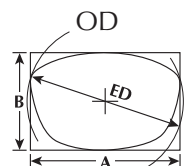

A	B	ED
46	30	48

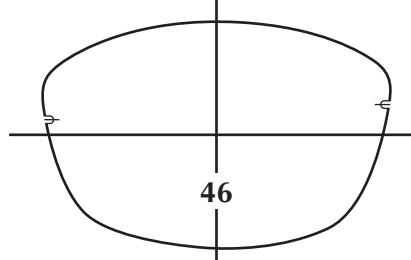
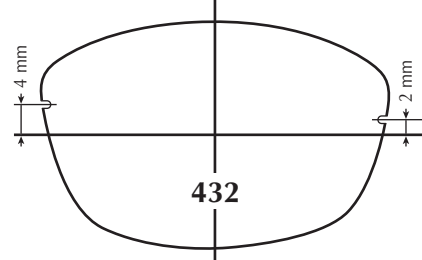
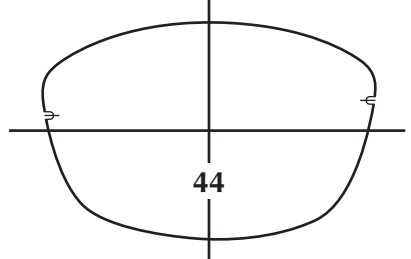
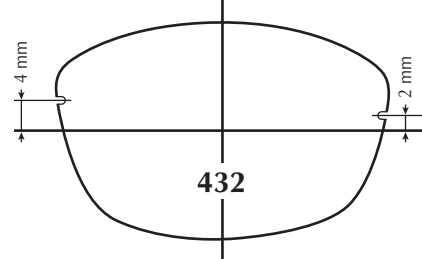
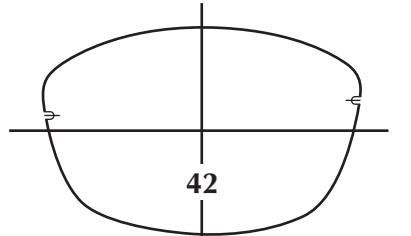
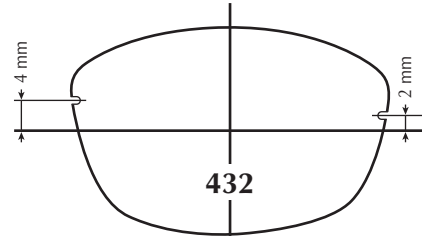
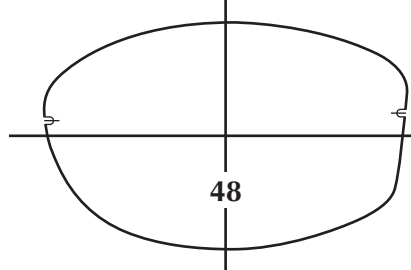
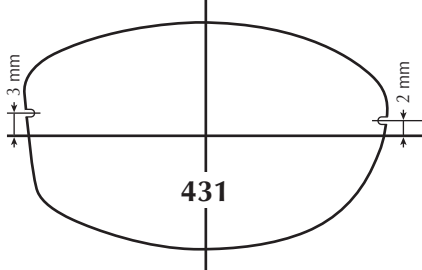
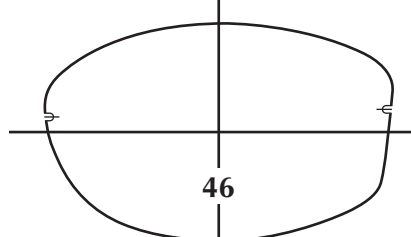
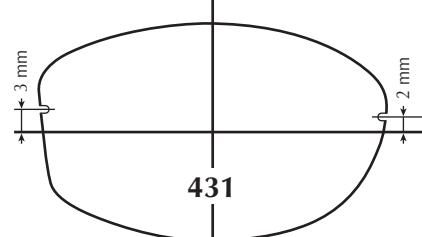
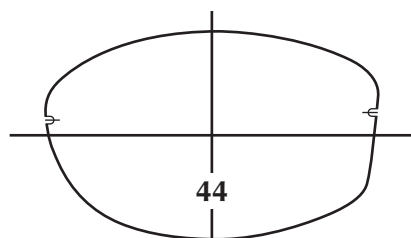
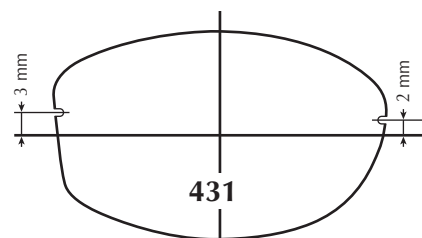

Toutes ces informations sont communiquées à titre indicatif et doivent être adaptées à la forme du nez du porteur.
All infos provided must be adapted to shape and size of the patient's nose.

⚠ Attention : certaines imprimantes peuvent ne pas reproduire ce document à l'échelle exacte.
Note: some printers may not duplicate this document at the correct scale.



M-Junior-22
M-Junior-22G

M-Junior

Pont traditionnel Junior
Junior traditional bridge

M-Junior-22
M-Junior-22G

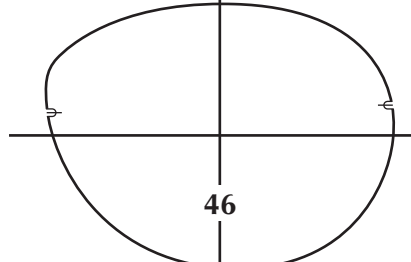
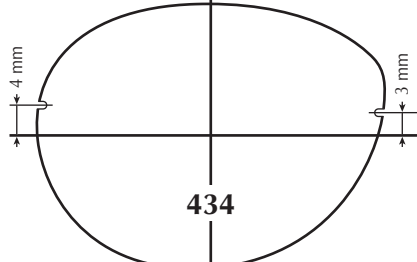
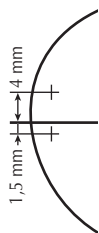
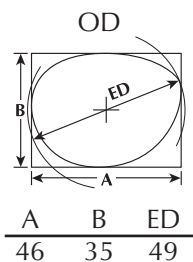
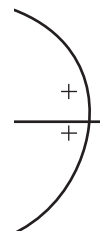
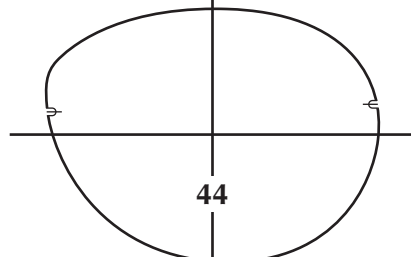
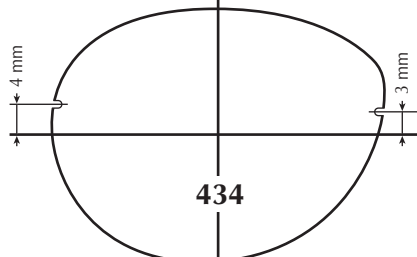
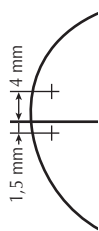
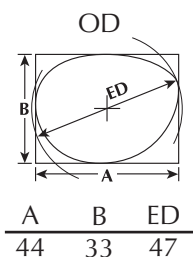
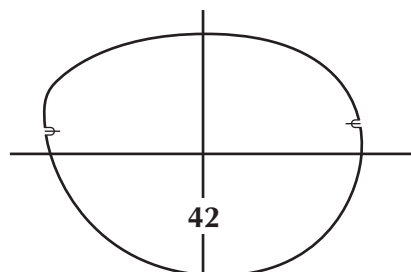
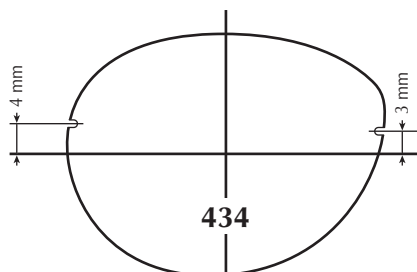
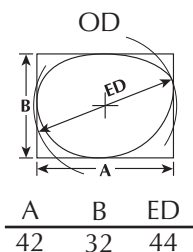
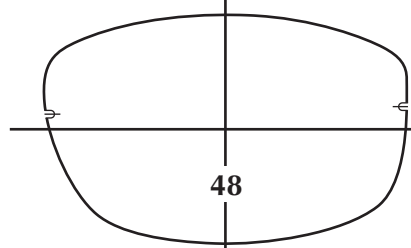
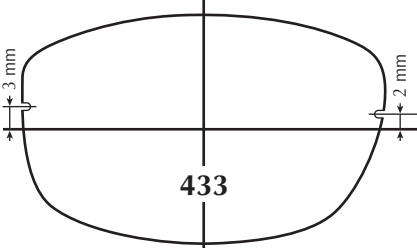
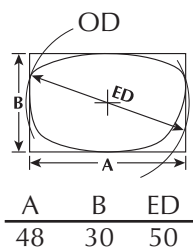
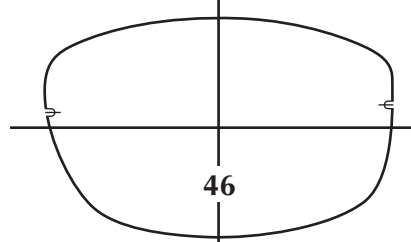
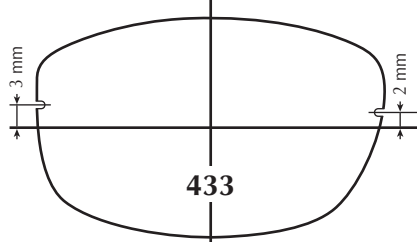
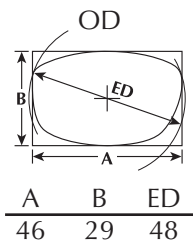
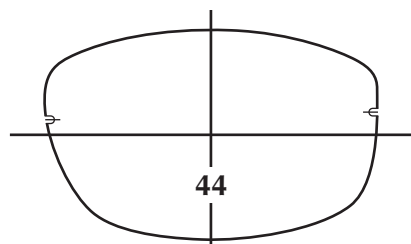
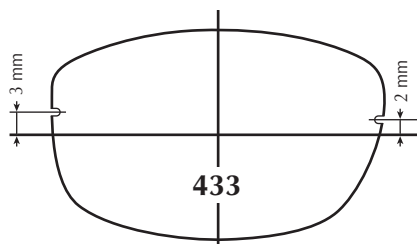
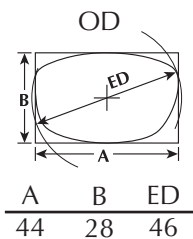

Toutes ces informations sont communiquées à titre indicatif et doivent être adaptées à la forme du nez du porteur.
All infos provided must be adapted to shape and size of the patient's nose.

⚠ Attention : certaines imprimantes peuvent ne pas reproduire ce document à l'échelle exacte.
Note: some printers may not duplicate this document at the correct scale.



M-Junior-22
M-Junior-22G

M-Junior

Pont traditionnel Junior
Junior traditional bridge

M-Junior-22
M-Junior-22G

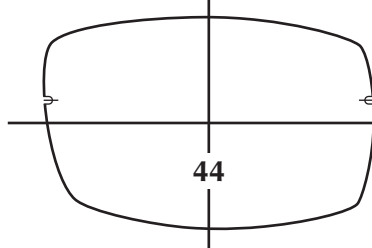
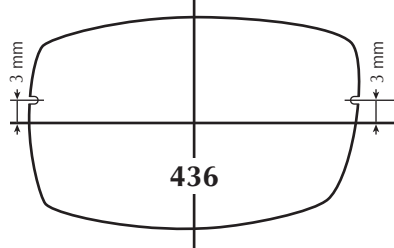
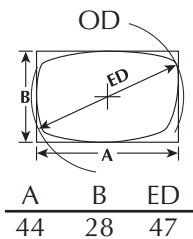
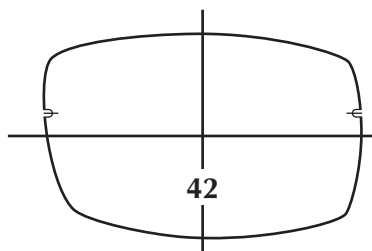
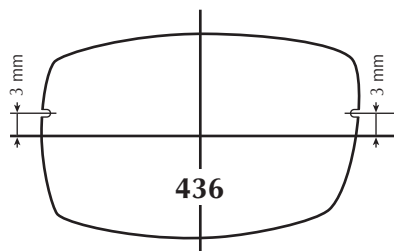
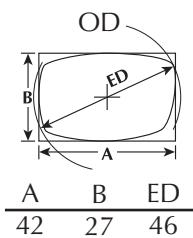
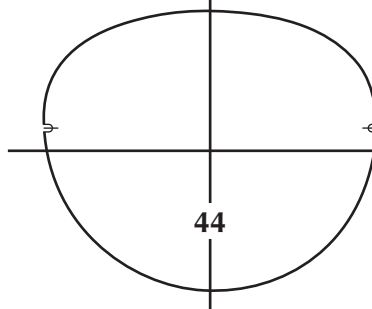
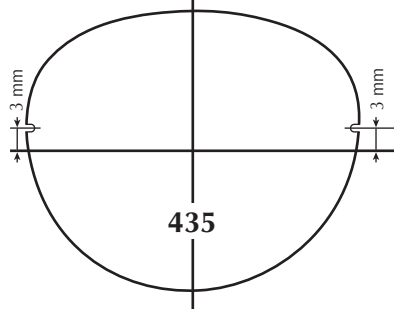
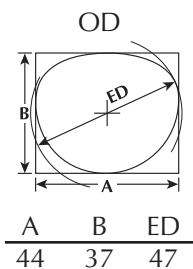
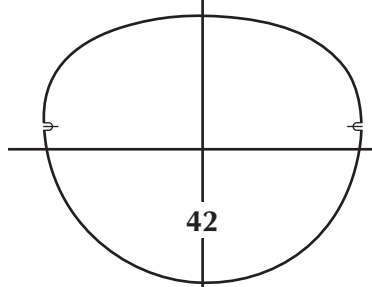
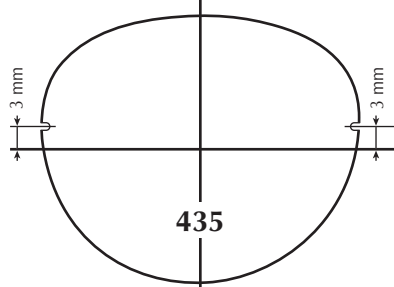
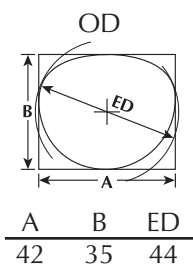
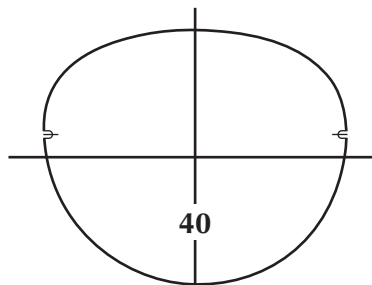
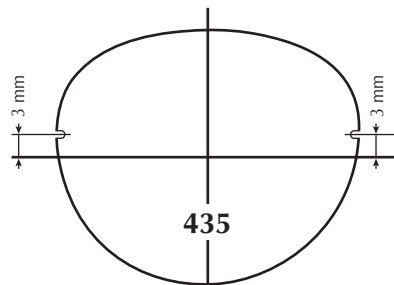
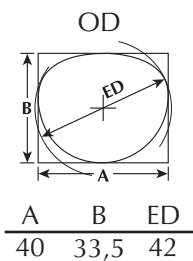

Toutes ces informations sont communiquées à titre indicatif et doivent être adaptées à la forme du nez du porteur.
All infos provided must be adapted to shape and size of the patient's nose.

⚠ Attention : certaines imprimantes peuvent ne pas reproduire ce document à l'échelle exacte.
Note: some printers may not duplicate this document at the correct scale.



FRANCE

Minima SAS
4, avenue Delage – 91310 Linas
Tél.: 01 69 01 03 03
Fax: 01 69 01 69 19
commande@minima.fr

Export

Tél.: +33 1 64 49 84 39
Fax: +33 1 64 49 39 92

DEUTSCHLAND

Minima GmbH
Lilienthalstr.8 – 10965 Berlin
Tel. 030-69817594
Fax. 030-69817596
deutschland@minima.fr

SUISSE

Minima SAS
Numéro gratuit : 0800 85 85 87
commande@minima.fr

PORTUGAL

Minima SAS
Número verde: 800 833 145
Fax: 800 833 144

BELGIQUE

Minima SAS
Numéro vert: 080074926
commande@minima.fr

UNITED KINGDOM

Minima SAS
Free phone number: 0808 234 0103
sales-uk@minima.fr

CONTACT